



# Nashorn

1/48  
SCALE

山折り Mountain fold  
谷折り Valley fold

切れ込み Cut  
切り抜く Cut out

貼り合わせる Paste together  
のりしろ Glue

1/5  
PAGE

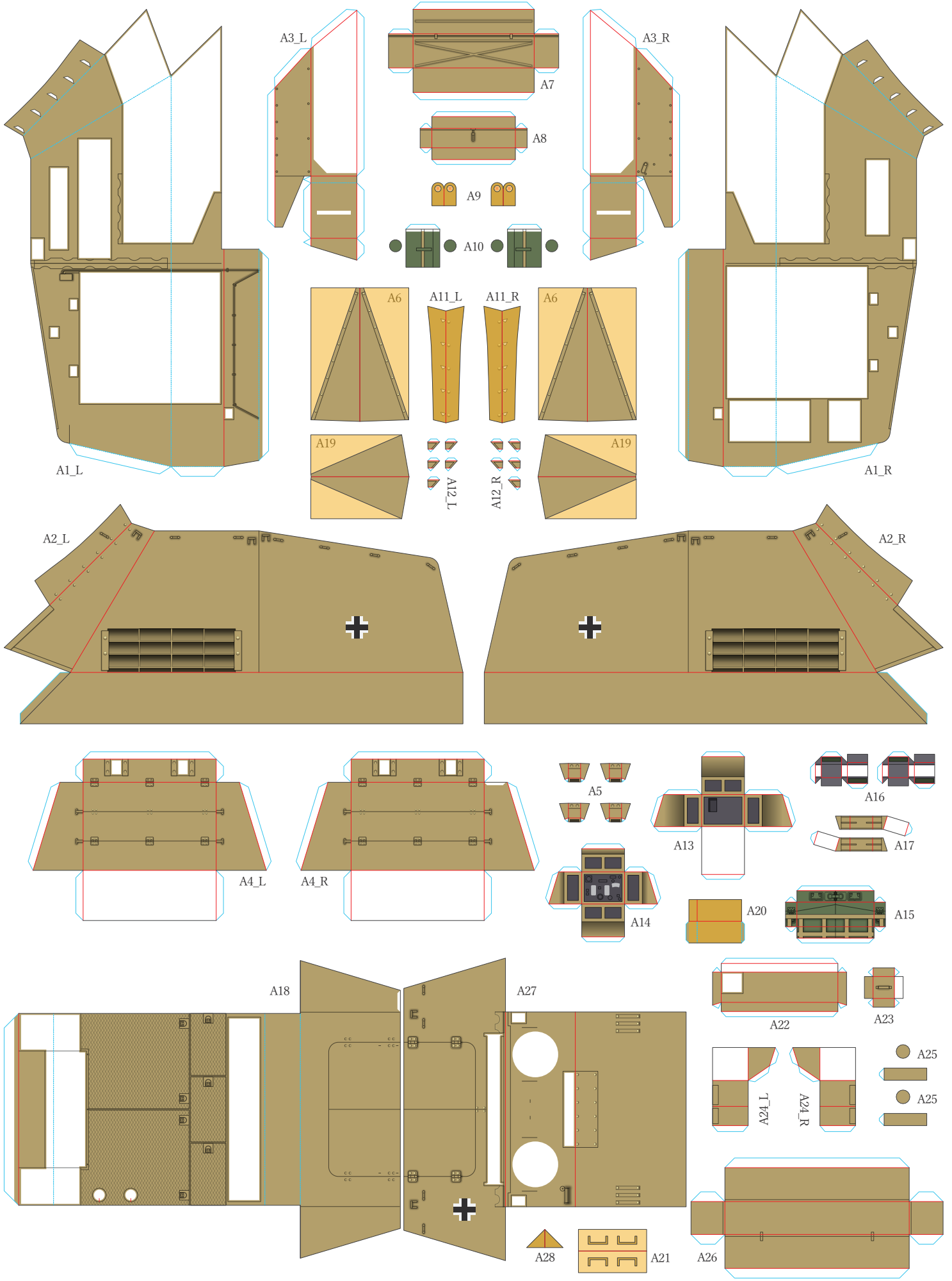



# Nashorn

1/48  
SCALE

山折り Mountain fold  
谷折り Valley fold

切れ込み Cut  
切り抜く Cut out

貼り合わせる Paste together  
のりしろ Glue

2/5  
PAGE

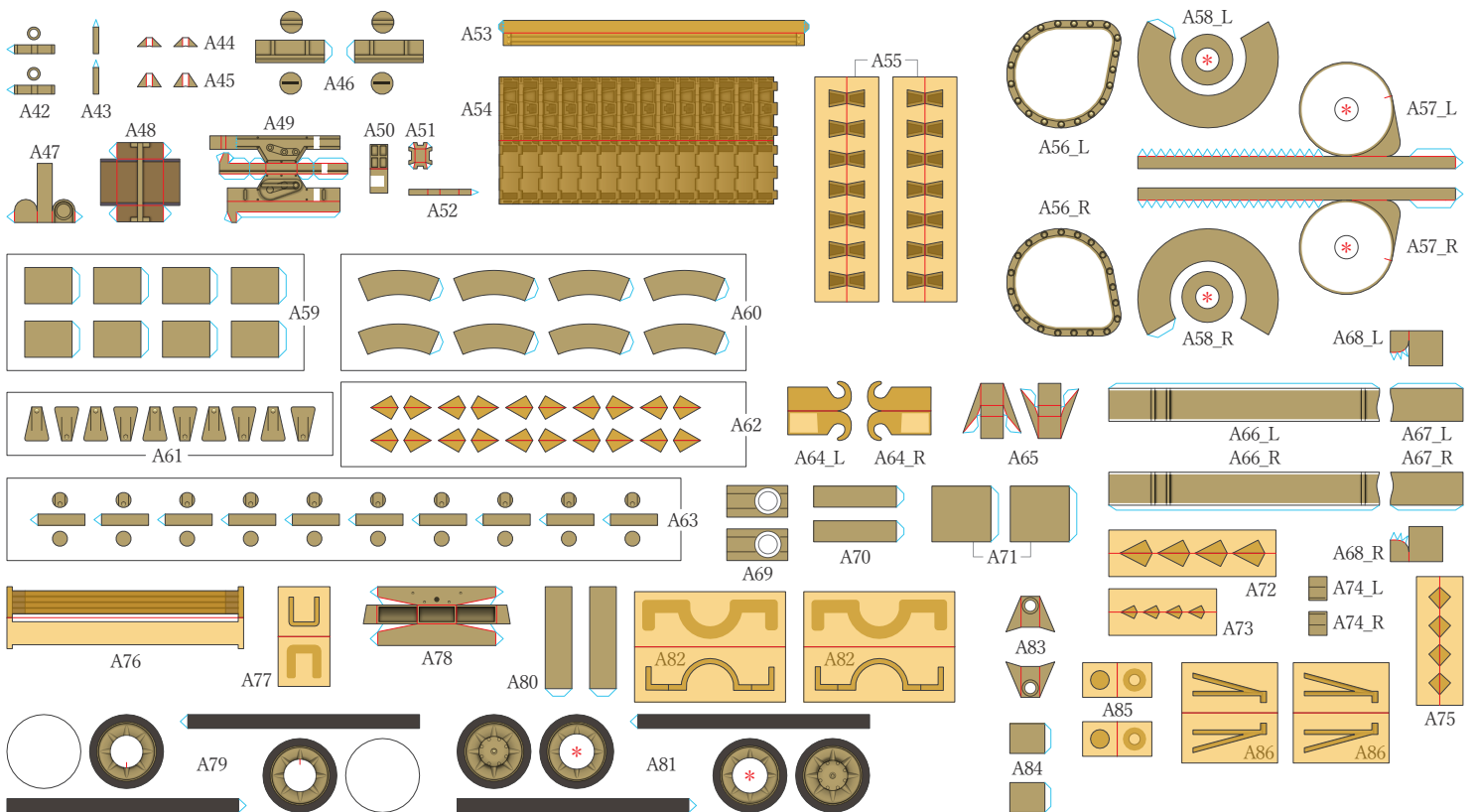
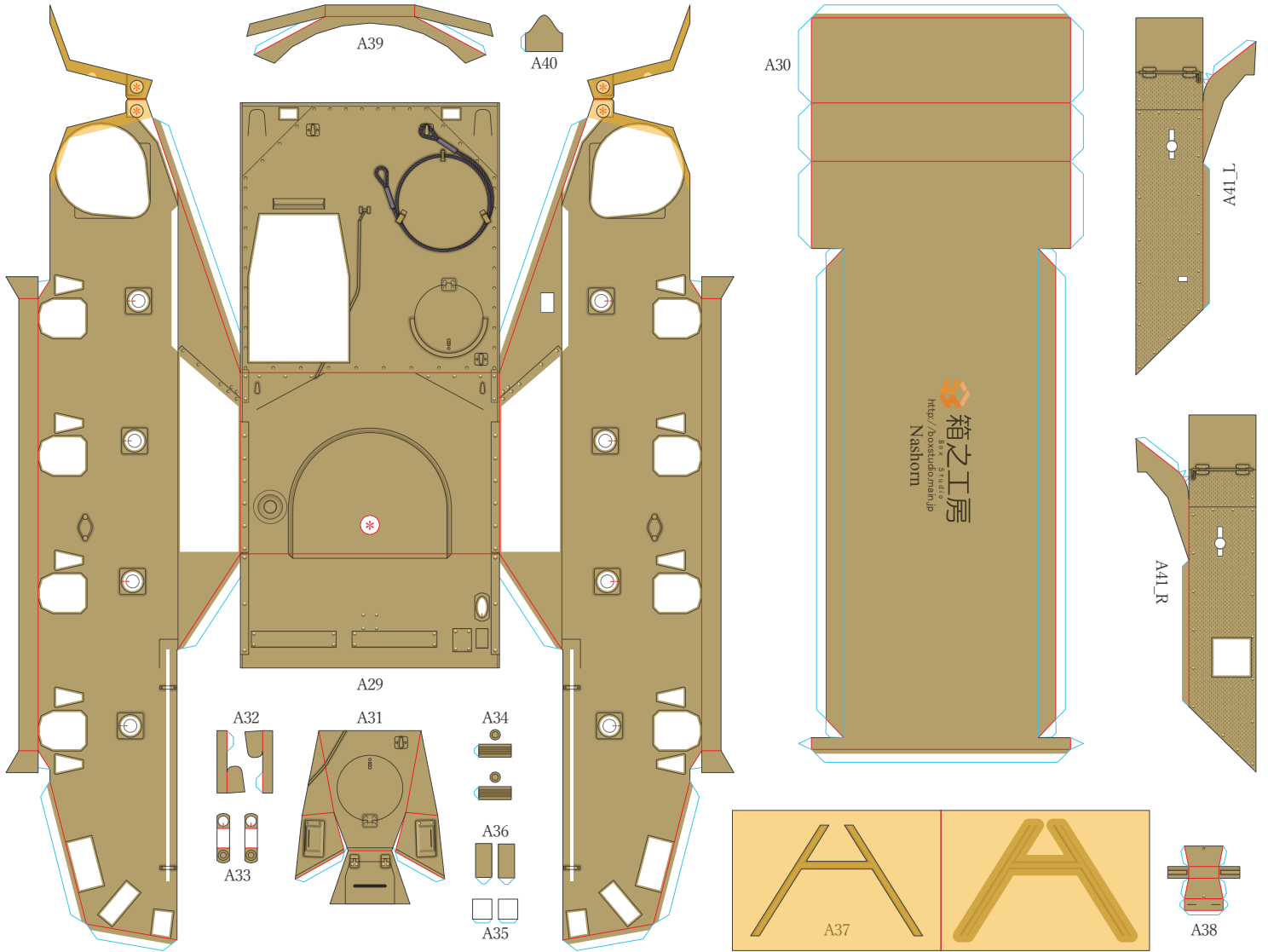



# Nashorn

1/48  
SCALE

- 山折り Mountain fold
- - - 切れ込み Cut
- 貼り合わせる Paste together
- - - 谷折り Valley fold
- \* 切り抜く Cut out
- └ のりしろ Glue

3/5  
PAGE

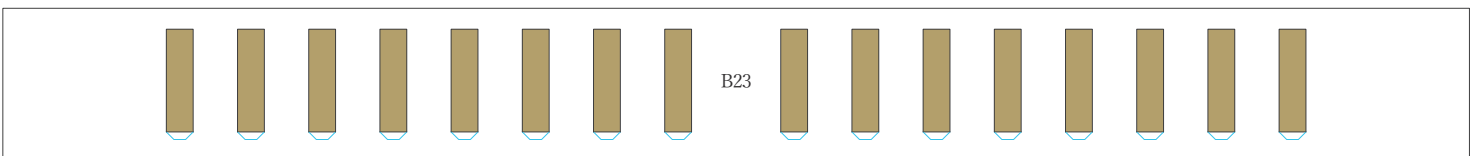
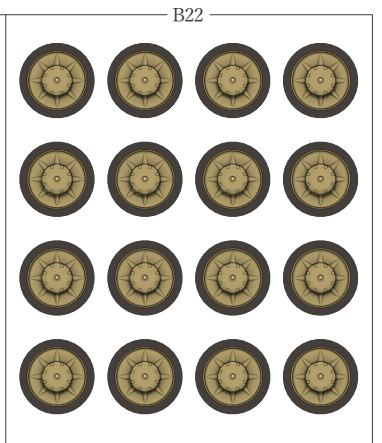
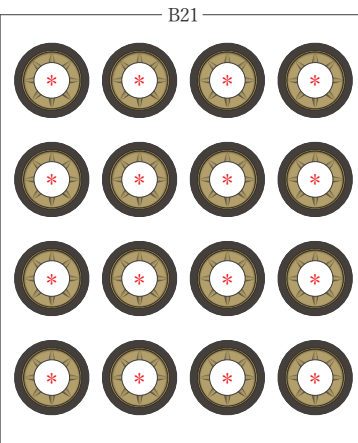
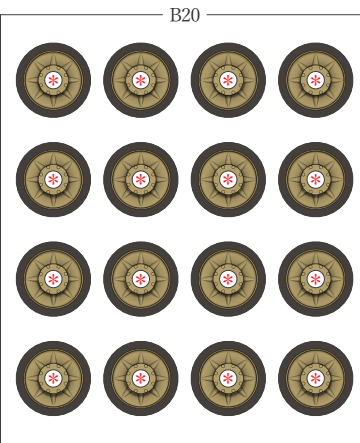
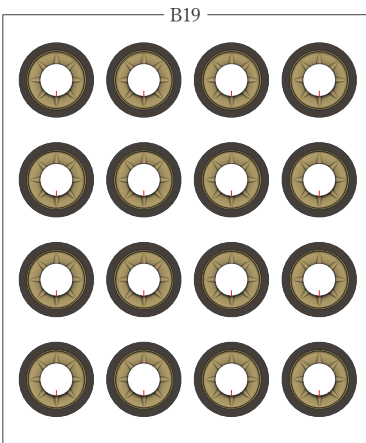
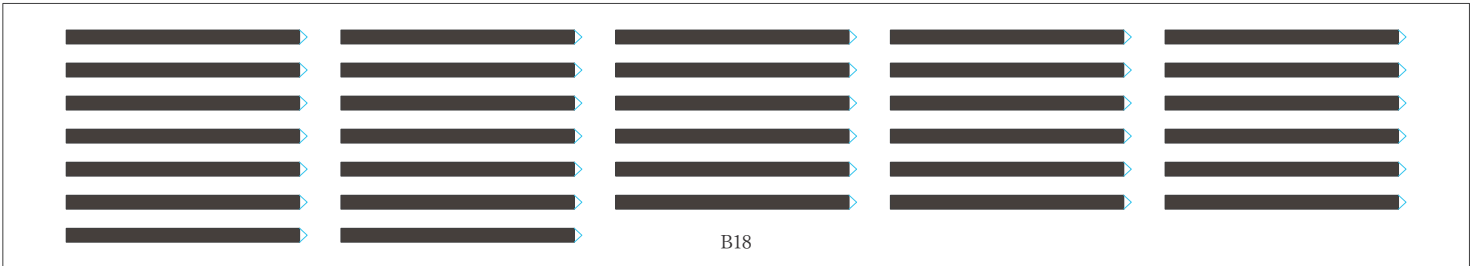
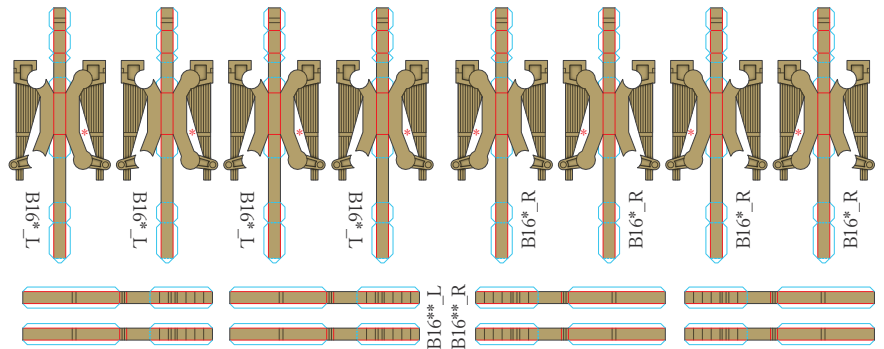
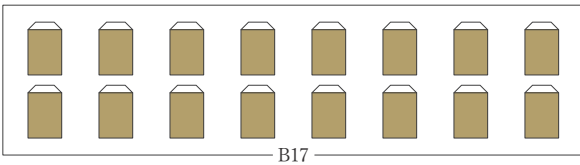
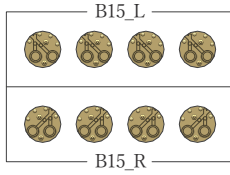
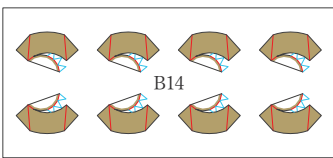
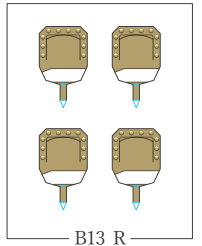
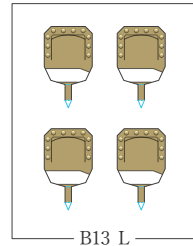
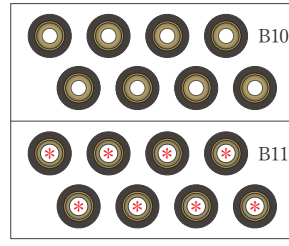
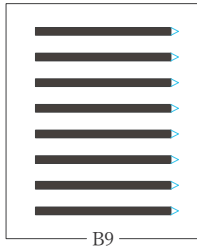
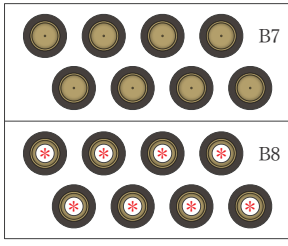
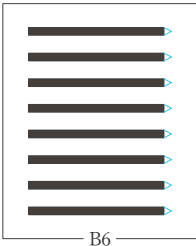
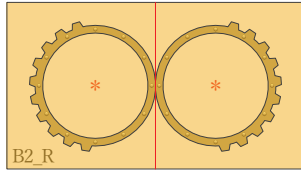
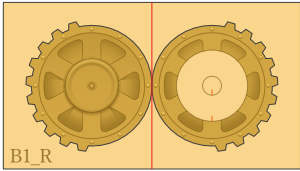
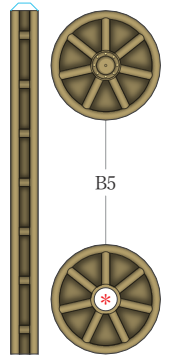
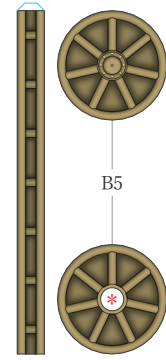
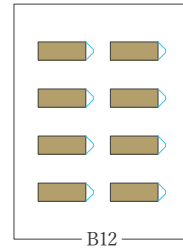
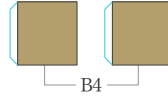
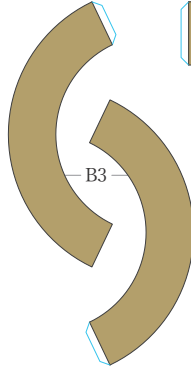
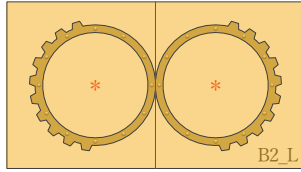
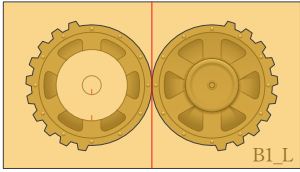



# Nashorn

1/48  
SCALE

山折り Mountain fold  
谷折り Valley fold

切れ込み Cut  
切り抜く Cut out

貼り合わせる Paste together  
のりしろ Glue

4/5  
PAGE

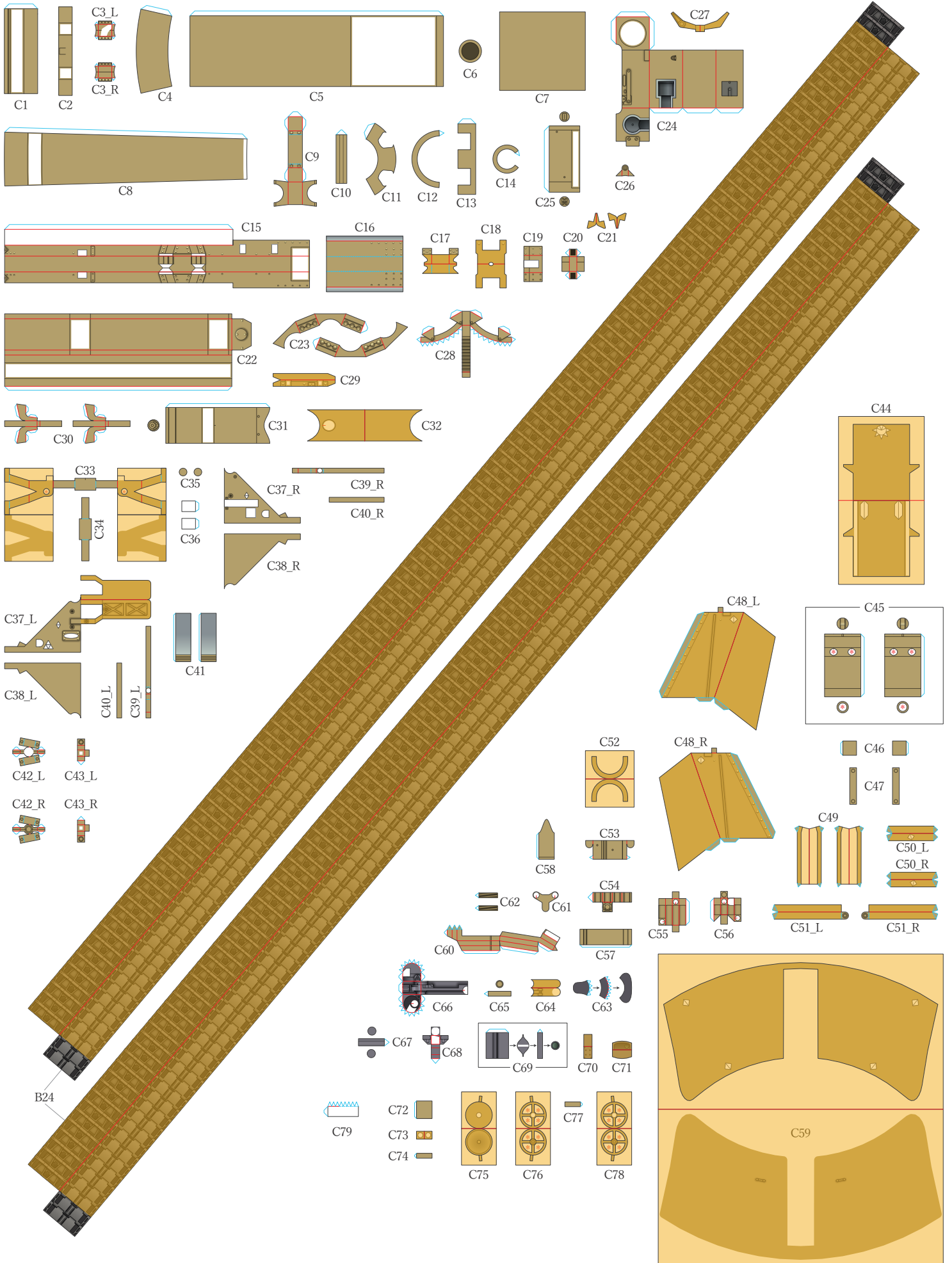



# Nashorn

1/48  
SCALE

山折り  
Mountain fold  
谷折り  
Valley fold

切れ込み  
Cut  
切り抜く  
Cut out

貼り合わせる  
Paste together  
のりしろ  
Glue

5/5  
PAGE

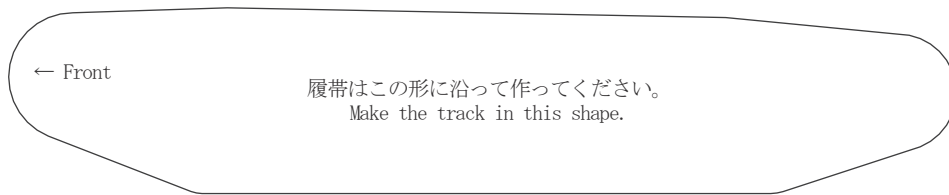
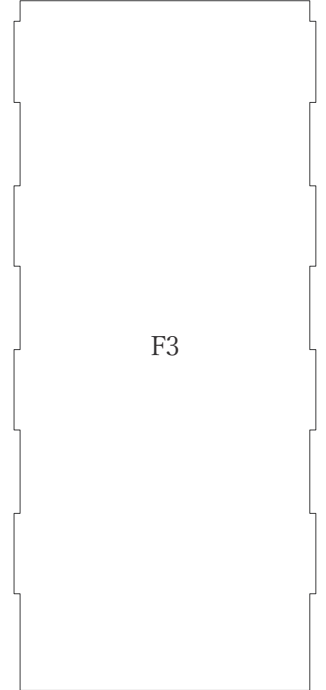
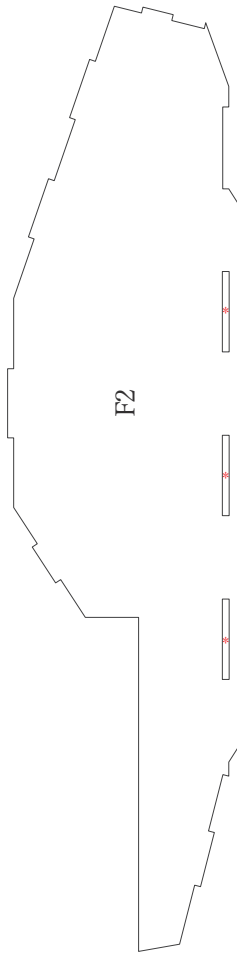
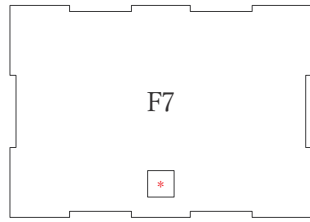
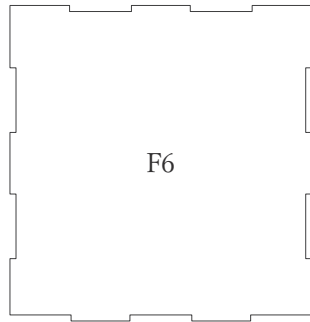
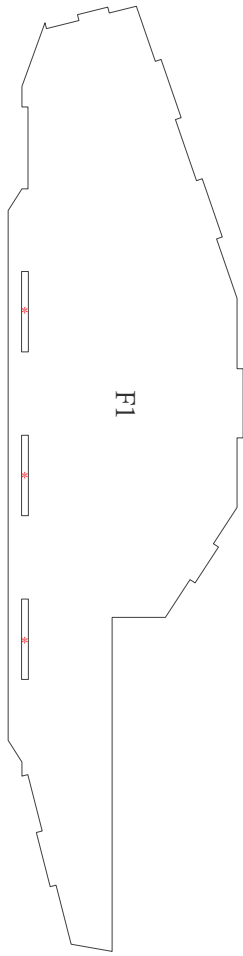

← Front

履帯はこの形に沿って作ってください。  
Make the track in this shape.