



Nashorn

1/48
SCALE

山折り Mountain fold
谷折り Valley fold

切れ込み Cut
切り抜く Cut out

貼り合わせる Paste together
のりしろ Glue

1/5
PAGE

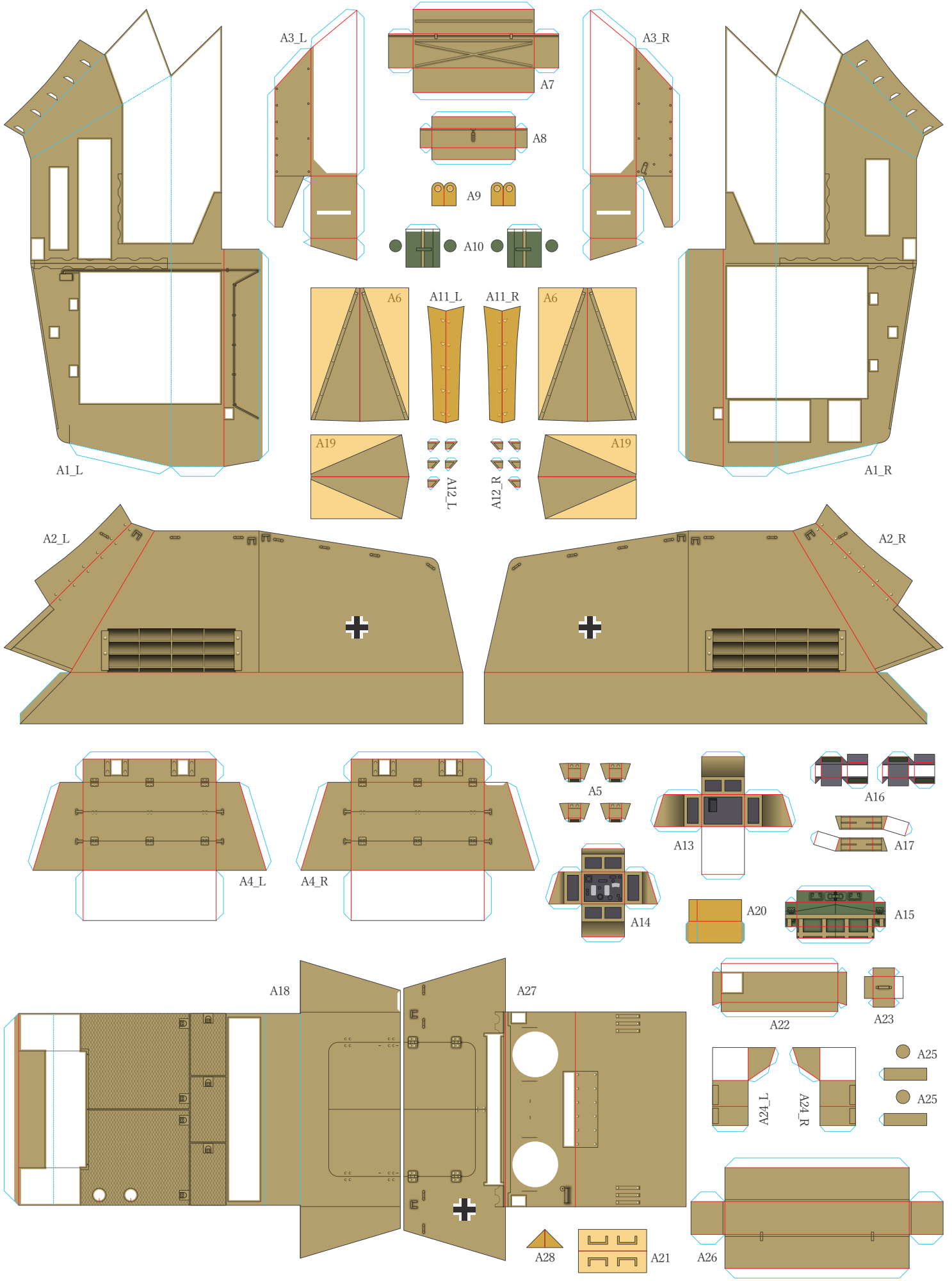



Nashorn

1/48
SCALE

山折り Mountain fold
谷折り Valley fold

切れ込み Cut
切り抜く Cut out

貼り合わせる Paste together
のりしろ Glue

2/5
PAGE

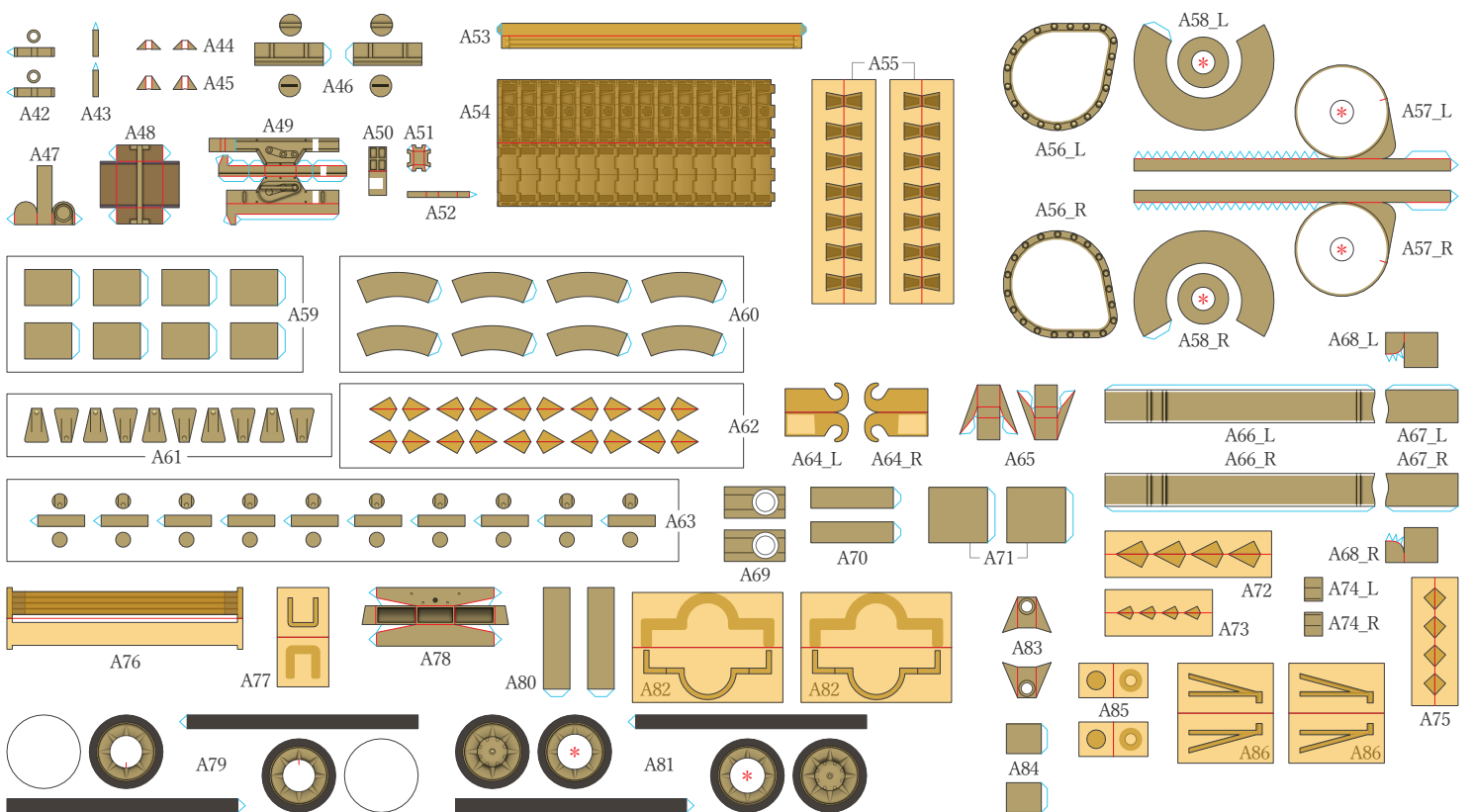
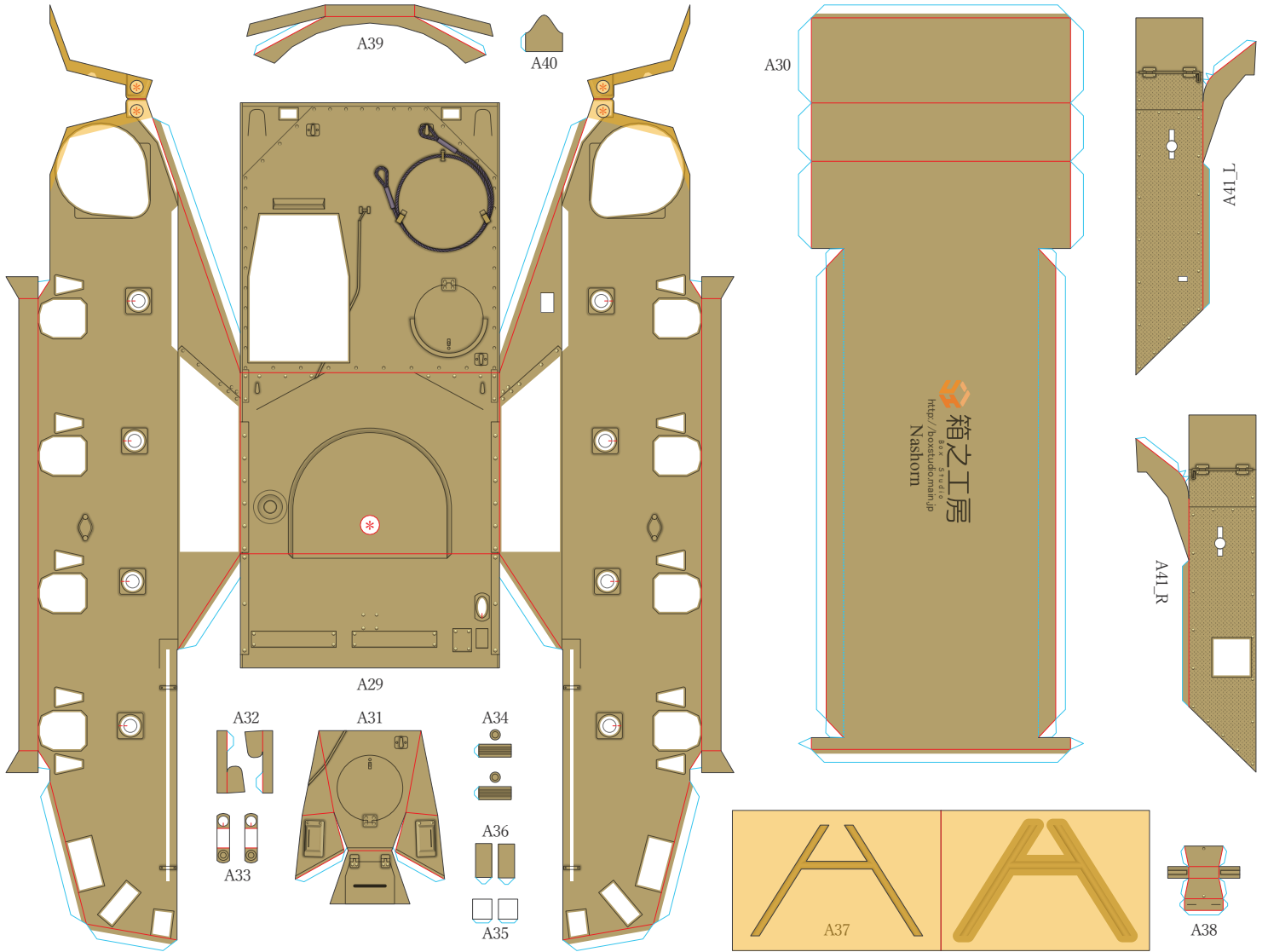



Nashorn

1/48
SCALE

- 山折り Mountain fold
- - - 切れ込み Cut
- 貼り合わせる Paste together
- - - 谷折り Valley fold
- * 切り抜く Cut out
- └ のりしろ Glue

3/5
PAGE

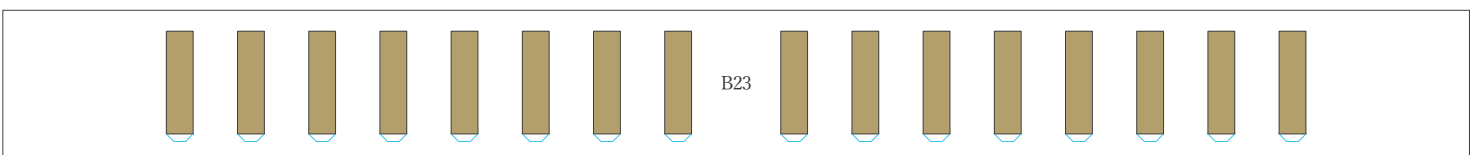
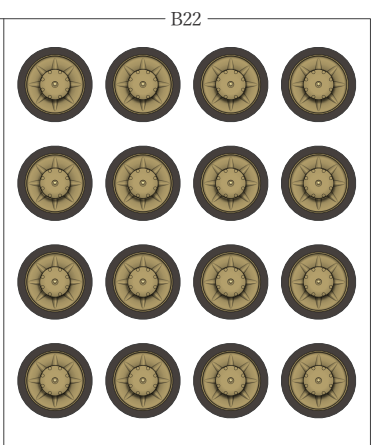
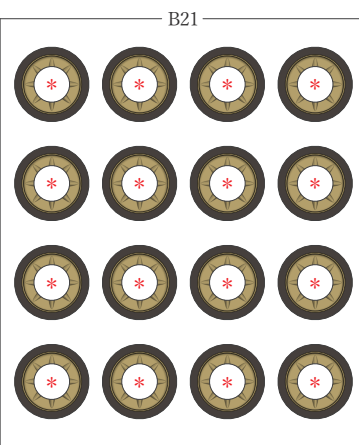
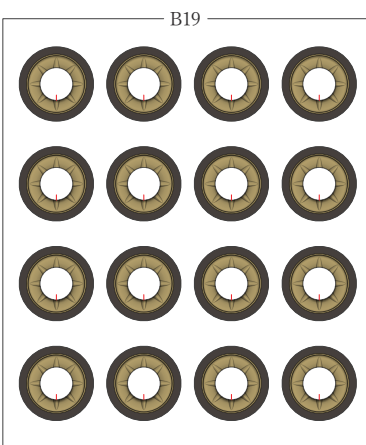
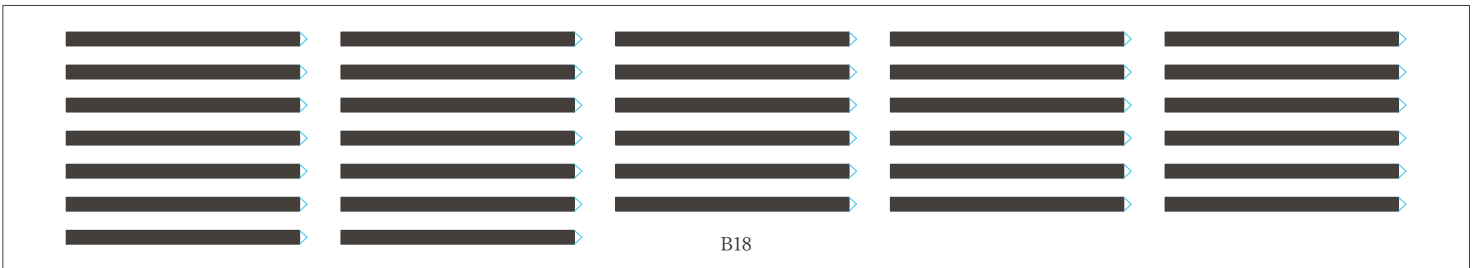
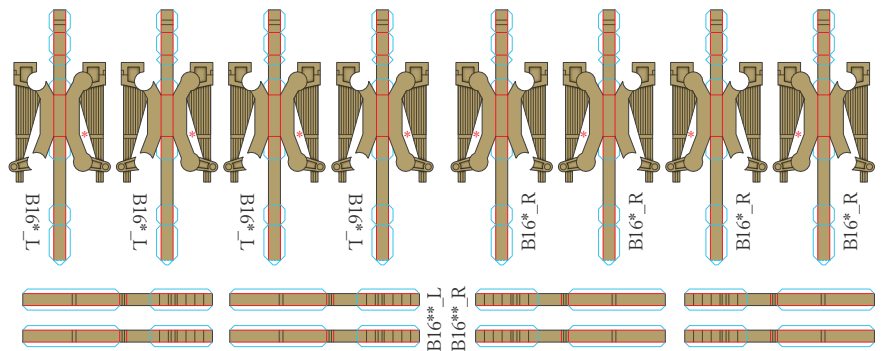
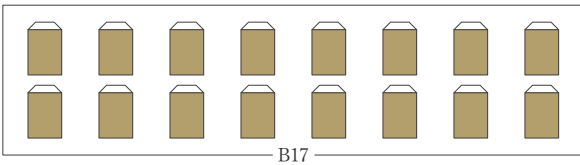
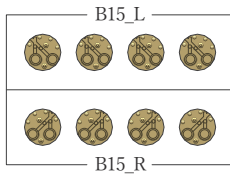
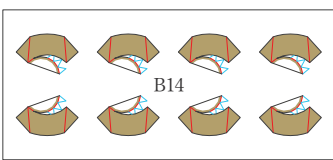
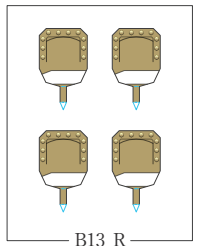
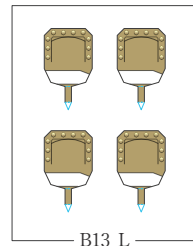
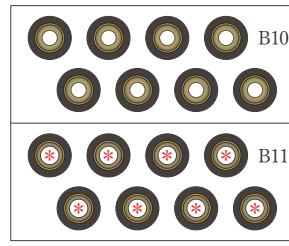
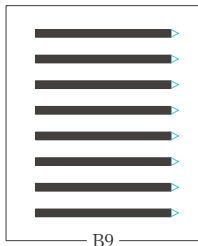
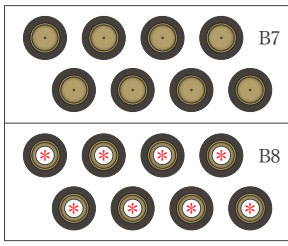
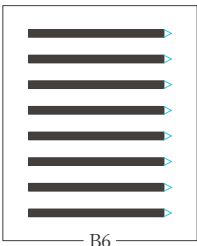
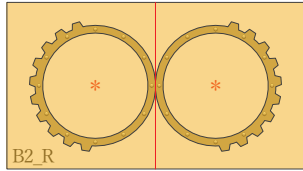
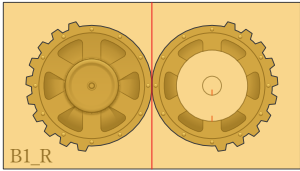
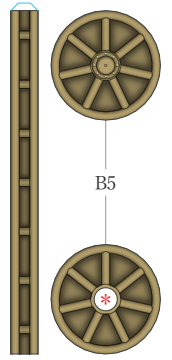
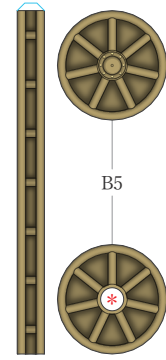
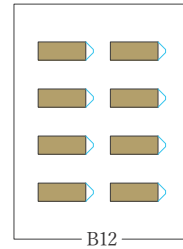
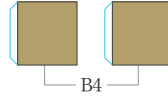
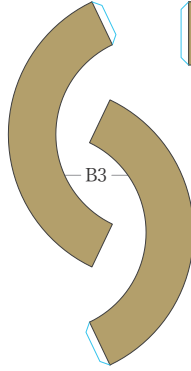
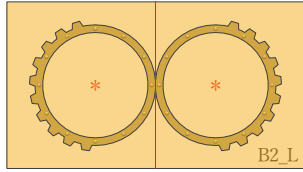
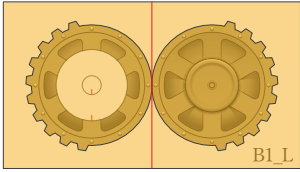



Nashorn

1/48
SCALE

山折り Mountain fold
谷折り Valley fold

切れ込み Cut
切り抜く Cut out

貼り合わせる Paste together
のりしろ Glue

4/5
PAGE

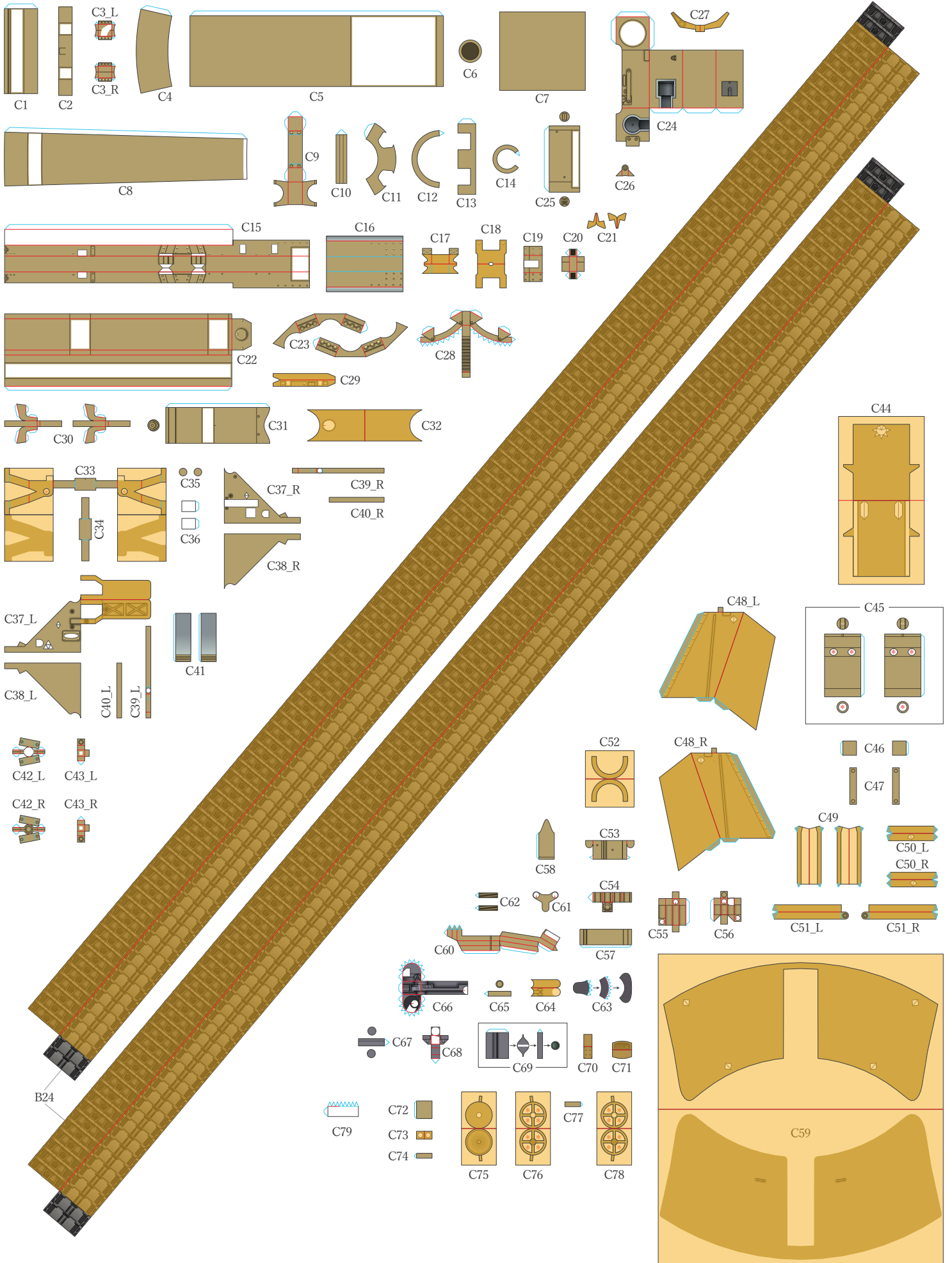



Nashorn

1/48
SCALE

山折り
Mountain fold

切れ込み
Cut

貼り合わせる
Paste together

谷折り
Valley fold

* 切り抜く
Cut out

のりしろ
Glue

5/5
PAGE

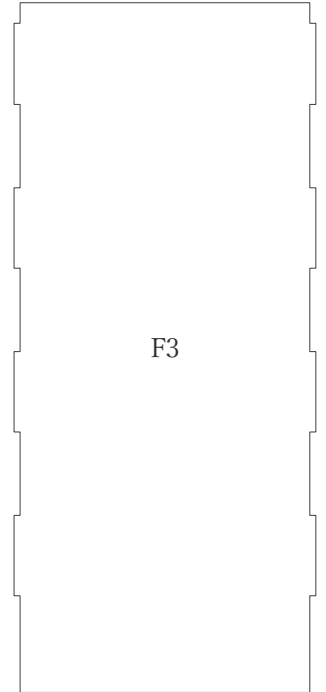
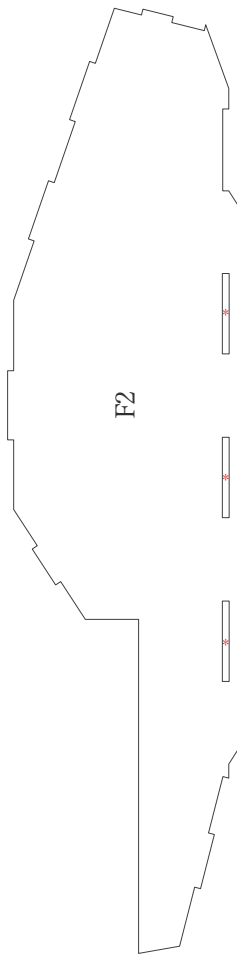
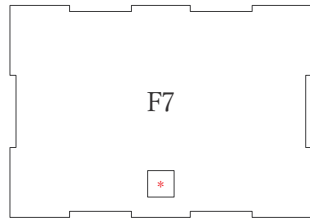
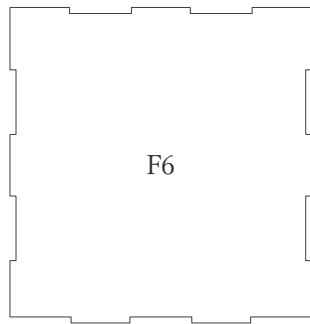
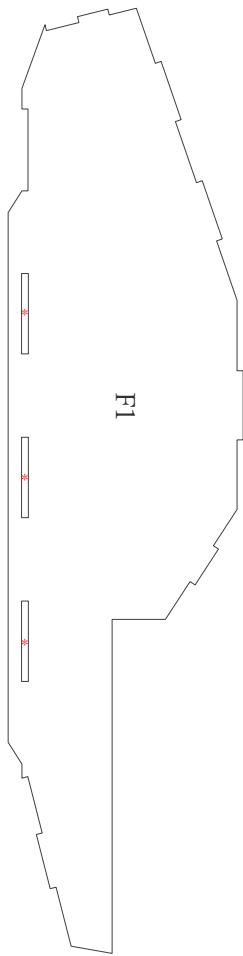

← Front

履帯はこの形に沿って作ってください。
Make the track in this shape.